

Worksheet 2 - Similar Figures using Proportion

Each pair of figures is similar. Find the missing side using a proportion.

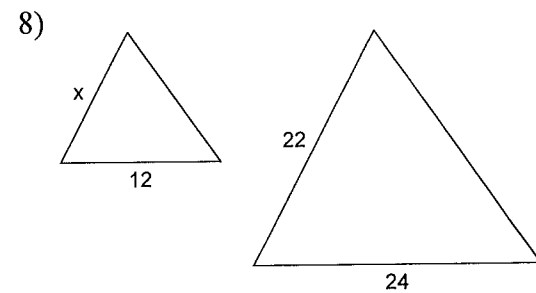

9)

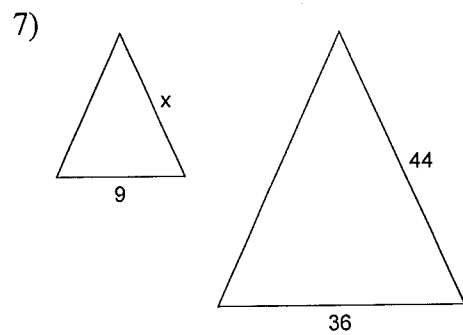
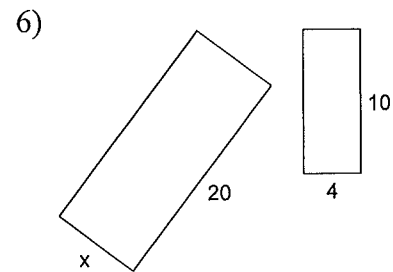
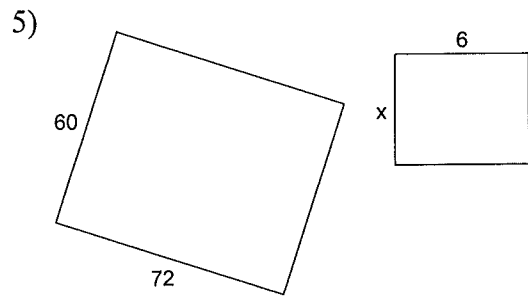
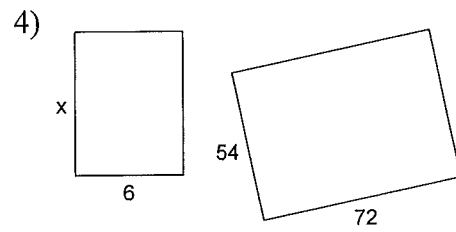
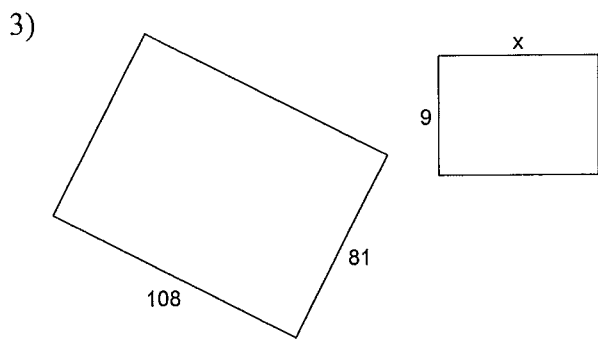
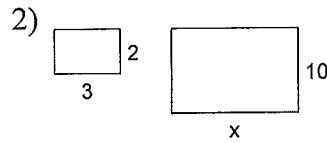
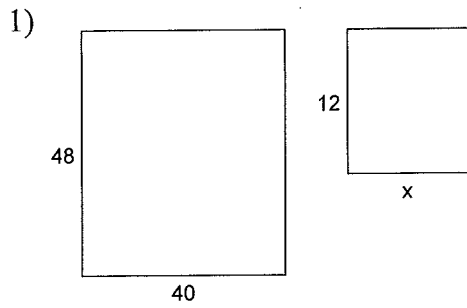
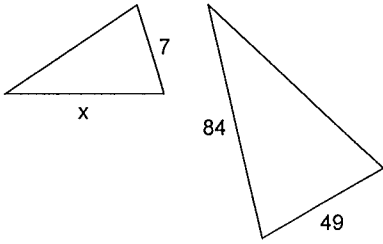

10)

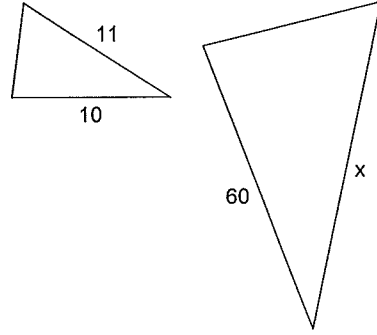

11)

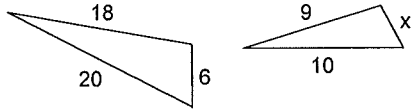

12)

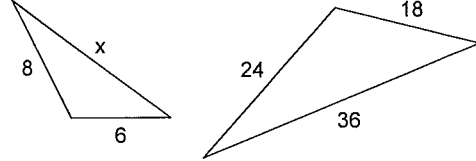

13)

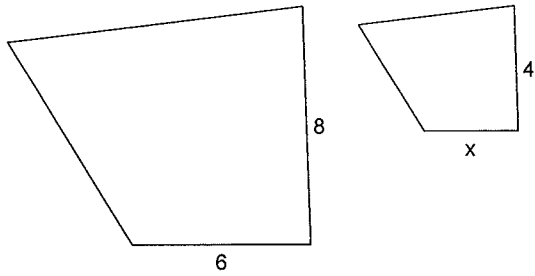

14)

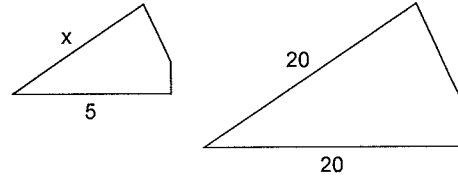

15)

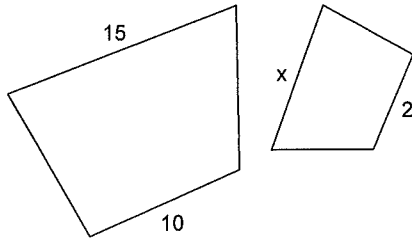

16)

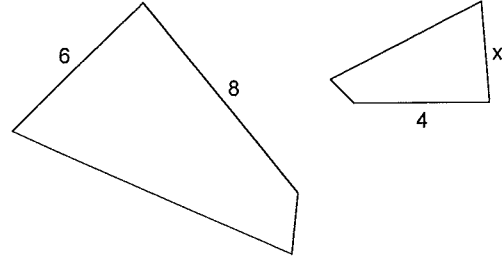

17)

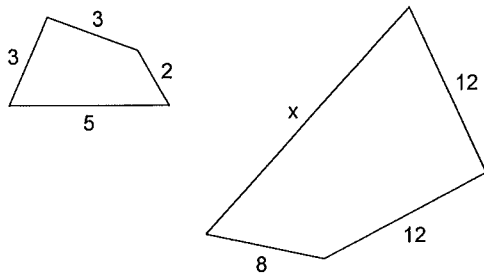

18)

